

SOUL

SERIES 2



User's Manual

zümex

Thought you knew the world of juice?

Get ready to change your perception forever.



You have the first ever Smart Juicer, Soul Series 2, in your hands.

The first automatic juicer, capable of offering the purest juice to your customers and the best performance for your business.

The future starts today: innovation and the most authentic style fit in the smallest space.

Small. Smart. Stylish

TECHNICAL CHARACTERISTICS ↓

JUICES CITRUS FRUIT

- ORANGES
- MANDARINS
- LEMONS*
- LIMES

*We recommend that you juice lemon varieties with a rounded shape and thin skin. For example: Eureka, Lisbon, Meyer.

SIZES

64-81 mm

Other optional kits:

Kit S → 45-65 mm

Kit XS → 42-52 mm

AUTONOMY FOR THE USER

3-6 oranges | 7-8 limes



DIMENSIONS

300 x 480 x 537 mm
11.8" x 18.9" x 21.1"

SPEED

1 JUICE IN → 10"

18 PIECES OF FRUIT → 1'

WEIGHT	32 kg	71 lb
VOLTAGE	100-240 VAC	50/60 Hz
POWER	100 W	0.134 hp
MAXIMUM CONSUMPTION	0.4-3.4 A (100-130 VAC)	0.3-1.5 A (220-240 VAC)
SOUND PRESSURE LEVEL	Below 60 Db	
ANTI-MOISTURE PROTECTION	IPX0	

*Remember to contact your usual distributor for any technical query

Patent:
 ES2567101A1. WO2016059186A1
 ES2527974B1. WO2013182712A2
 Pat. Pending: P201930926
 DMC: 007055652

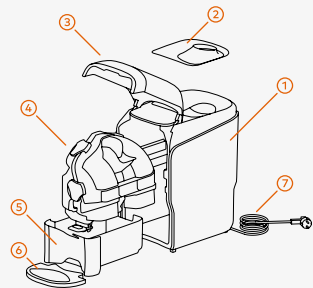
FIG. 1 → Soul Series 2

- | | |
|---|-----------------------|
| 1 | SOUL SERIES 2 |
| 2 | FEEDER LID |
| 3 | FRONT DOOR |
| 4 | CASE OUT |
| 5 | WASTE COLLECTION TRAY |
| 6 | CUPHOLDER TRAY |
| 7 | MAINS CABLE |

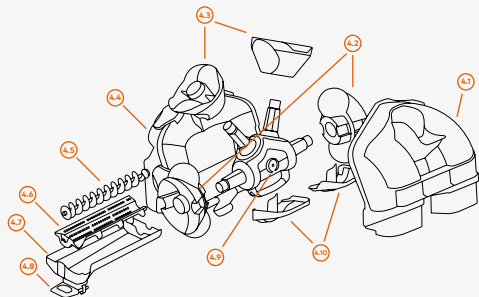
FIG. 2 → Case Out Unit (4)

- | | |
|------|-------------------------------|
| 4.1 | FEEDER CASE |
| 4.2 | LOWER PRESSING UNITS |
| 4.3 | UPPER PRESSING UNITS |
| 4.4 | CUTTING CASE |
| 4.5 | PULP EXTRACTOR SCREW CONVEYOR |
| 4.6 | PULP EXTRACTOR FILTER |
| 4.7 | JUICE CONTAINER |
| 4.8 | TAP |
| 4.9 | SHAFTS UNIT |
| 4.10 | PEEL EJECTORS |

BEFORE YOU START, FOR YOUR SAFETY, TAKE INTO ACCOUNT

The specific details about your **Zumex Soul Series 2** juicer (voltage, frequency and other data of interest), can be found on the Identification Label that you will find inside the machine.

If you have any technical queries, you must get in touch with your regular **Dealer / Official Technical Support Service**, always stating the Serial Number on the machine Identification Label.

Zumex adopts the necessary measures to ensure that the machines placed on the market are selectively collected and managed in an environmentally respectful manner. Please contact your authorised Zumex dealer to correctly dispose of these machines.

The instructions may be updated without prior notice. You can consult them at any time on our website www.zumex.com, in the section on the selected model. If you have any suggestions or comments that you believe may improve our machines or service network, please get in touch with Zumex directly at the address below:

ZUMEX GROUP, S.A.

Polígono Ind. Moncada III C/Molí 2.
46113 Moncada. Valencia. España.
Tel. +34 961 301 251 Fax: +34 961 301 255
zumex@zumex.com / www.zumex.com

Warnings

Do not manipulate the machine in such a way that it works without safety elements.

This appliances are intended to be used for commercial applications, for example in kitchens of restaurants, canteens, hospitals and in commercial enterprises such as bakeries, etc., but not for continuous mass production of food.

The appliance is not intended to be cleaned with a water jet or a steam cleaner.

This appliance can be used by children over the age of 8 or older, or by people with impaired physical, sensorial or mental capacities or who lack experience or knowledge, if they are supervised or have received adequate training with respect to the safe operation of the appliance and they understand the risks entailed.

Children should be supervised to make sure they do not play with the appliance.

The cleaning and maintenance to be performed by the user must not be carried out by children without supervision.

This machine contains an equipotential terminal on the rear to connect the Earth Tap of other appliances to the

Earth Tap of your installation through this terminal. If you use it, slacken the nuts and washers, couple the Earth Tap cable of the auxiliary appliance and firmly tighten the nuts and washers again. This equipotentiality point is indicated with the following symbol:



Do not use other different fruit to that specified in the manual.

When you clean, perform maintenance or replace parts, make sure that you have always unplugged the power cable from the socket and it is visible.

Use the cutting elements with great care, to avoid possible cuts.

The parts that are in contact with food must be cleaned according to the instructions that you can read in the cleaning chapter.

If the power cable is damaged, it must be replaced with a cable or special unit to be supplied by the manufacturer or by the after-sales service.

1

A place for the juice of the future

Have you already thought about where you will place your Soul Series 2?

You can put it wherever you like thanks to its **size and 360° design**.

It will turn any space into a **designer juice corner**.

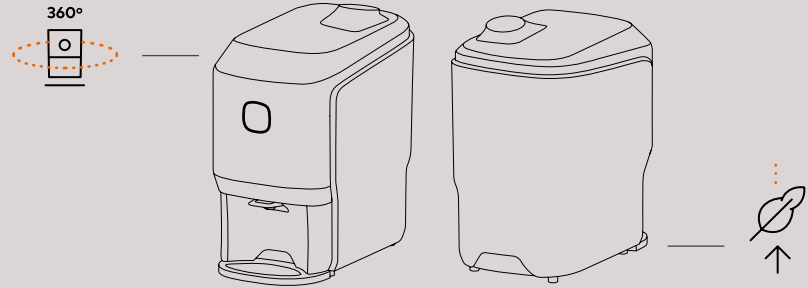

- 1 First of all, check that the mains voltage coincides with that shown on the Identification Label of the machine, which you will find both in this manual and on the machine itself.
- 2 Make sure there are no obstacles which may get in the way during the unpackaging process.
- 3 Then take the Soul Series 2 out of the packaging and place it on the flat surface you have ready.
- 4 The following components may be supplied loose. If this is the case, put them in position: Cupholder base, Cupholder, Mains cable.

You are just one step away from starting to juice with Soul Series 2.

SOME ADVICE BEFORE BEGINNING

Initial cleaning

We recommend that you clean the juicing system before first use. See the section "Cleaning".

Attaching the cupholder

To fix the cupholder to the machine, press the outer clips of the tray, then slide the piece up to the limit on it and release the clips.

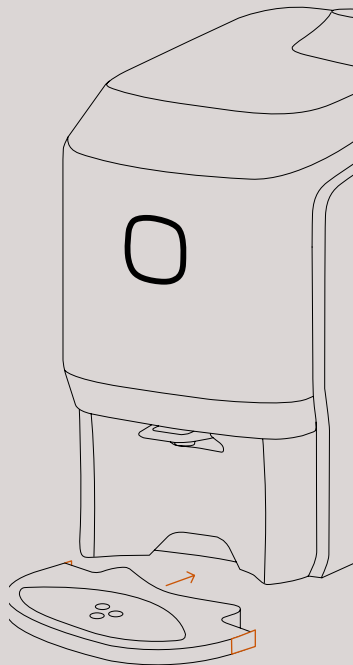

Start up

→ Check the electrical data of your machine with the electricity supply. Once the machine is correctly installed, proceed to plug it into the mains voltage.

→ After plugging in the machine, press the button for 1" to switch on the juicer, until a steady white light comes on. This means that the machine is ready to juice.

→ Check that the **Top lid**, **Waste collection tray** and the **Front door** are properly fitted. A flashing white light will appear if they are not. Remember to open the Tap (to the down position) and use a glass at the juice outlet.

Juicing unit

Check that all the Case Out parts have been mounted correctly.

Loading the feeder

The machine can fit 3/4 oranges in the feeder, depending on their size.

Waste collection zone

Ensure that the Waste collection tray is correctly fitted in its position and that the peel deflector is in the lowest position.

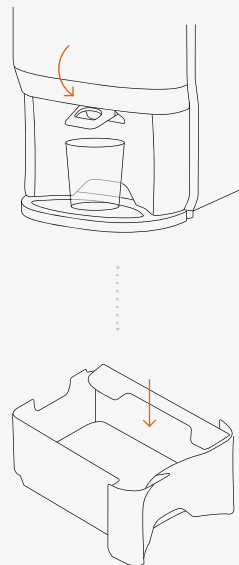

2

You are now a Smart Juicer: Connect your machine

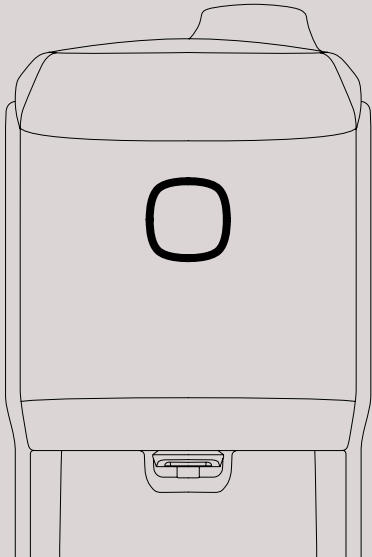
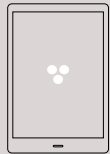

- 1 When you turn on the machine, it will emit this WiFi network: **Zumex Connect** to which you can connect with your mobile device, tablet or PC, using the PIN: 0000
- 2 Enter the URL into your browser: <http://8.8.8.8>
- 3 A screen with the option Settings > WiFi will appear. Enter your network parameters here.
Your machine is now connected to the internet!
- 4 From the same menu, you can set the language or access PIN, as well as other options.
- 5 On the website zumexconnect.com, access the Registration area and enter your machine's serial number and the Zumex Connect number*. Once registration is complete, you will receive your access details to the reports in an email.



You can also access them
by scanning the QR code.

*If you do not have this number, contact service@zumex.com, indicating the serial number of your machine.

3

Juicing is easier than ever

FOLLOW YOUR INTUITION: PUSH&JUICE!

Just touch the front button to juice. The button will change colour automatically from white to orange.

Pure Juice in record time.

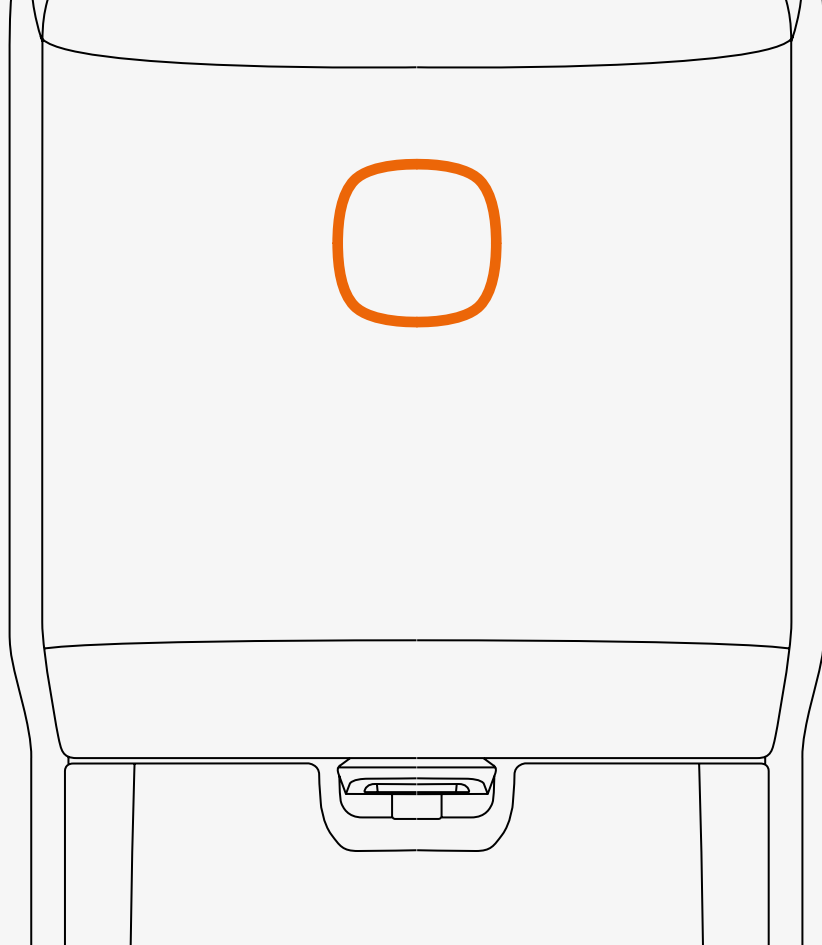

Understand the language of Soul

Observe the light of the button and the sound coming from the machine



White

The machine is ready to juice.



Flashing White

Waste collection tray incorrectly positioned.
Front door open.
Top lid incorrectly positioned.



Orange

The machine is juicing correctly.



Flashing Orange

Empty the waste collection tray.
Juicing system blocked.
PulpOut System blocked.



The machine will notify you with three beeps when the waste collection tray is full and needs to be emptied.

Switch your Soul off

You can switch your machine off as follows:

- By pushing the front button for 2".
- By unplugging the mains cable directly.
- If the machine does not detect any oranges, it will stop, approximately 20" after the last orange has gone through.

Important

Please, never attempt to access the juicing zone from the feeder with your hand, to avoid accidents.

Never operate the machine from the side or from the back. Always load the feeder from the front of the machine.



Easy to clean, like everything in Soul

- 1 Disconnect the machine from the mains and remove any obstacles from around the machine.
- 2 Raise the **Front door** up with your hand as far as it will go. To close it, gently move it down with your hand until you hear a slight click.
Important! For safety reasons, the machine will not start up unless the door is fully closed.
- 3 The **Case Out** is removed in two steps:
 1. Hold of the **Front handle (A)** and pull it carefully outwards, sliding it along the guides until the Case Out reaches the end of the guides in the front area.
 2. Hold the **Side handles (B)** of the Case Out in your hands, gently lifting it over the front stops, and pull it out, sliding it along the **guides (C)**. Carry the unit in the same position to prevent dripping. To put it back in the machine, take hold of it by the handles with both hands, take the two guides at the left and right of the machine interior as your reference, and insert the unit inwards as far as it will go.
- 4 Carefully support the **Case Out** on a flat surface to disassemble it, resting it on its left face and leaving the latches on that side. Open the four latches to disassemble the **Feeder Case**.
- 5 Pull the Case upwards.
- 6 Remove the two peel ejectors, left and right, from the **Feeder Case** for subsequent cleaning.

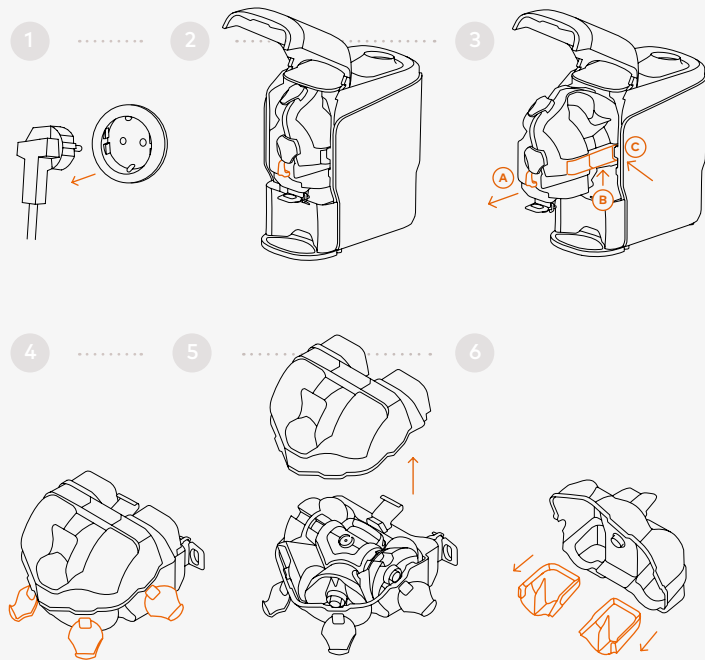

Easy to clean, like everything in Soul

- 7** Once the feeder case lid is removed, take out the sweeper unit located in the cutting housing by moving the tab at the far right of the tray and sliding the whole unit outwards to take it off the guides of the cutting housing. You will find the screw conveyor and the filter inside this sweeper unit tray. Take them out. Zumex recommends thorough cleaning of the tap with the brush supplied. Press the back tab to unclip the Tap and take it out. To put it back in, position it in front of the tap support holes and fit it into them.
- 8** Take the whole pressing units and shafts unit out by pulling the handle on its central support upwards.
- Warning!** Take care with the cutting zone!
Take care with the blade when removing the shafts and pressing units unit.
- 9** Remove the **Waste collection tray** to empty the peel.

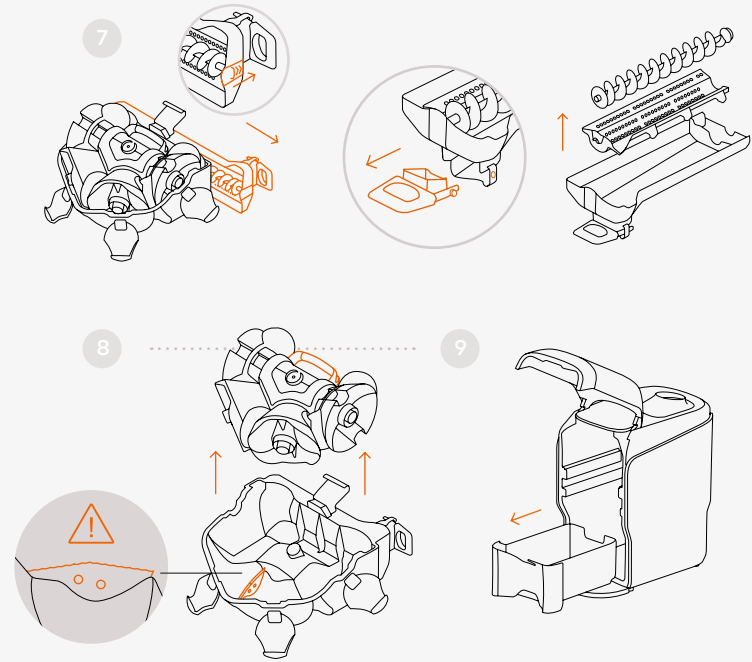

Easy to clean, like everything in Soul

10

Cleaning is very easy. Rinse the parts with water, helping yourself to remove pulp remains with a soft brush or with a sponge.



Zumex recommends using the **Zumex Citric Active** cleaner to improve machine cleaning results, especially for removing waxes. The machine needs to be sanitised with a disinfectant after every cleaning.

You may remove the **Pressing units** for deeper cleaning. Turn the **Pressing unit latches** a quarter of a turn to remove the **Lower pressing units** and the **Upper pressing units**.

You can also wash all the parts in the dishwasher. You should use the soap, salt and rinse aid correctly so that the parts do not lose their shine.

Important! The Shafts unit (4.9) with its central support is an indivisible unit. You should not disassemble it.

To mount the pressing units, slide the corresponding pressing unit along the guide until fully in position. Make sure that both pressing units fit together perfectly. Turn the **Pressing unit latches** a quarter of a turn and make sure that the latches support the pressing units correctly.

11

You can clean the inside of the machine with a soapy dishcloth. Then rinse and dry. Avoid using a rough cloth which may damage the inner surface of the machine. You can use a wet rag or soapy dishcloth with mild soap to clean the outside of the machine.

10

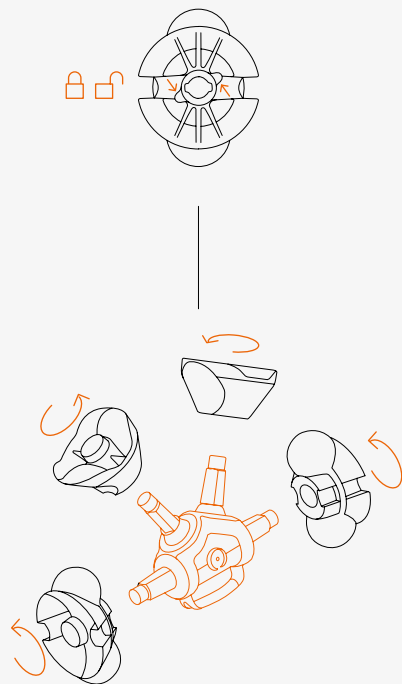

Zumex Tips

We recommend daily cleaning in depth and that you follow these hygiene and disinfection instructions step by step to ensure the proper operation and durability of your juicer.

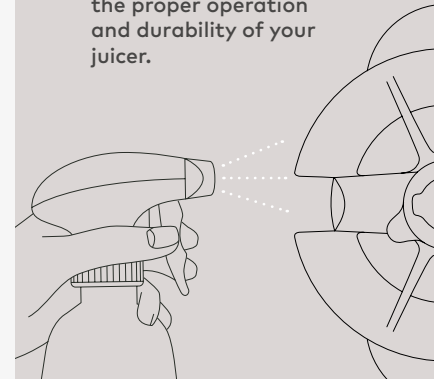

4

Don't let anything stop you

Frequently asked questions.

1 → My Zumex Soul does not turn on

Check that it is plugged into the mains. Check that there is voltage in the socket by plugging any other appliance into the socket and seeing if it works. If the electricity socket is working, check that you have connected the plug into the socket correctly, and into the machine. If the button still does not come on nor flash, touch the button for 1".

2 → My machine does not juice

Check that the machine is connected and touch the button.

3 → There is no light on the button

Access the Juicing unit to check that nothing is causing a blockage inside.

4 → No juice coming out?

Check that the tap is open. If the juice is still not coming out, clean the tap by disassembling it as indicated in the cleaning section and making sure it remains open. You can test it by pouring a glass of water into the system through the feeder zone. Check that the filter inside is not stopped up, and clean it.

5 → You hear noise but the oranges are not going in?

Stop the machine and disassemble it. Assemble it again by following the steps and checking that all the parts fit into each other perfectly.

6 → Why is there a white light on the front button?

This light means that the machine is ready to juice. No fault.

7 → Why is there a flashing white light?

This light appears when the machine is not juicing and/or:
 → The front door is not closed properly.
 → The waste collection tray is incorrectly positioned
 → The top lid is incorrectly positioned
 For the machine to be operational again, open and close the door, or unplug the machine.

8 → Why is there an orange light on the front button?

This light means that the machine is juicing correctly. No fault.

9 → Why is there a flashing orange light and an alert sound?

The machine will notify you with a flashing orange light and three beeps when the Waste collection tray is full of peel. Once it has detected that the tray is full, the machine will stop the juicing unit. After the notification, the button will go back to a white light. If you try to continue juicing and press the button again, the machine will not start up and will notify you by means of a longer steady beep. Empty the Waste collection tray to resume normal operation.

If a blockage in the juicing system or the pulp sweeper zone is detected during juicing, the machine will notify of the blockage by a steady beep and flashing orange light, which will continue until the door or tray is opened.

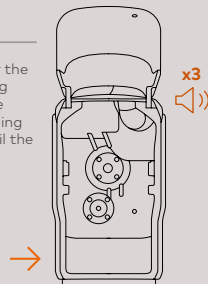

zumex®

www.zumex.com

