

Bin

B3

1.

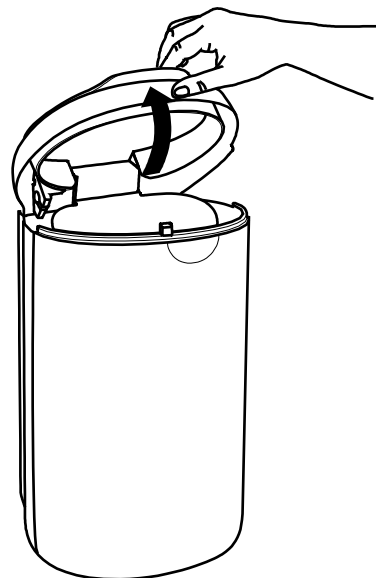

2.

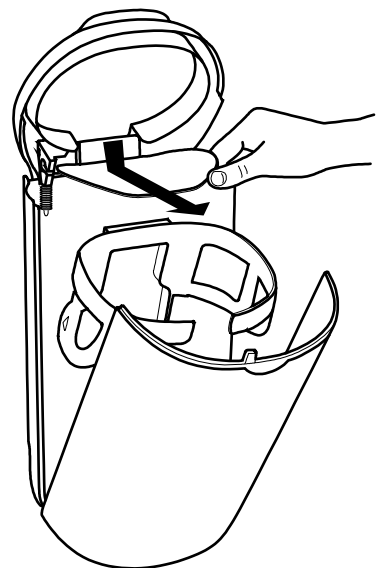

3.

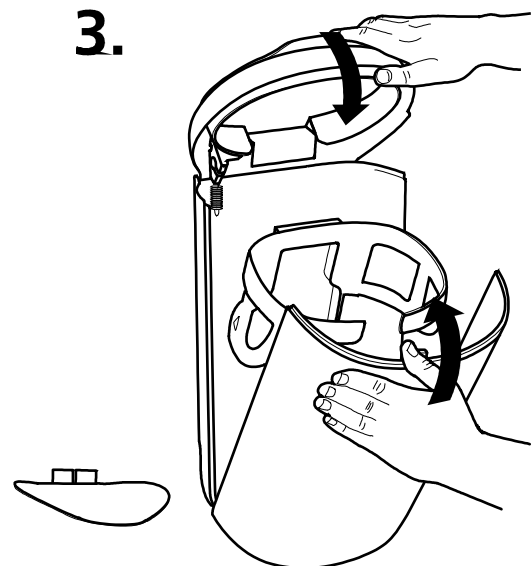

4.

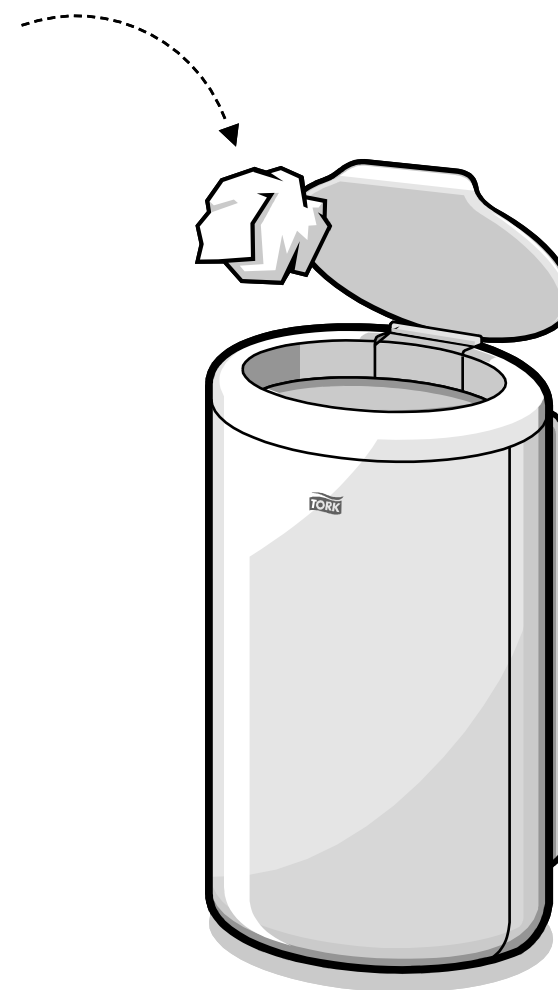
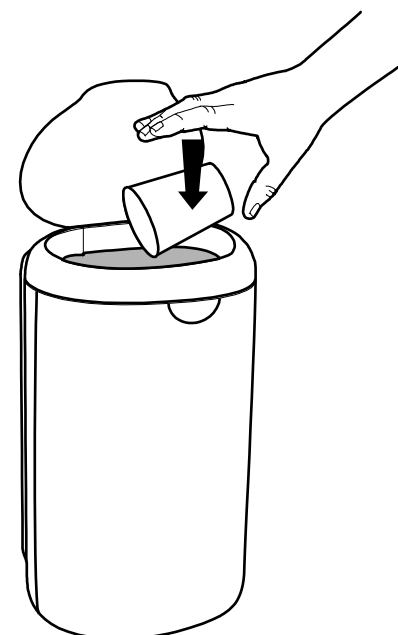

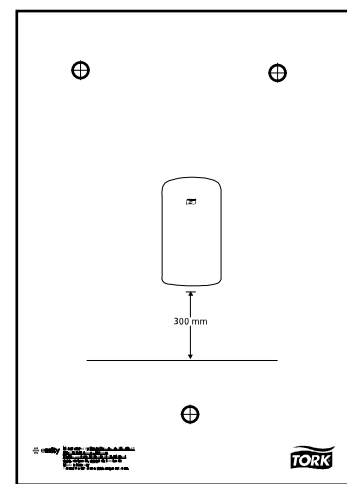
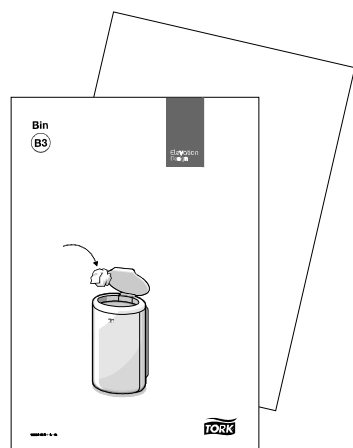
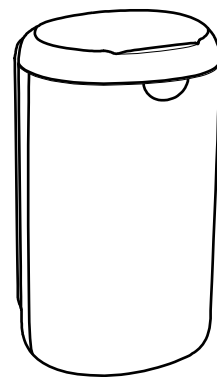
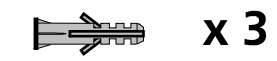
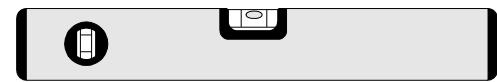
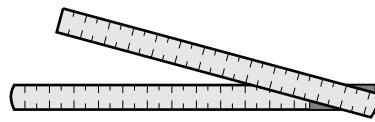
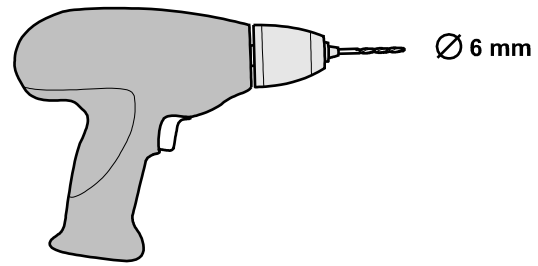
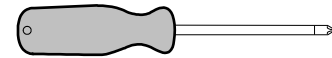
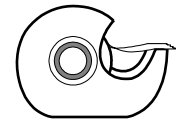
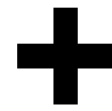
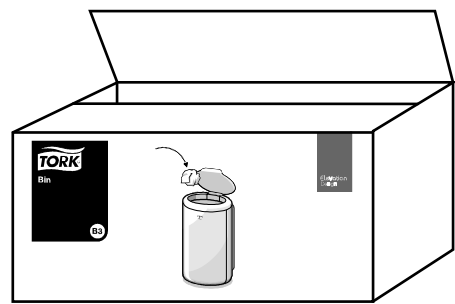

1.

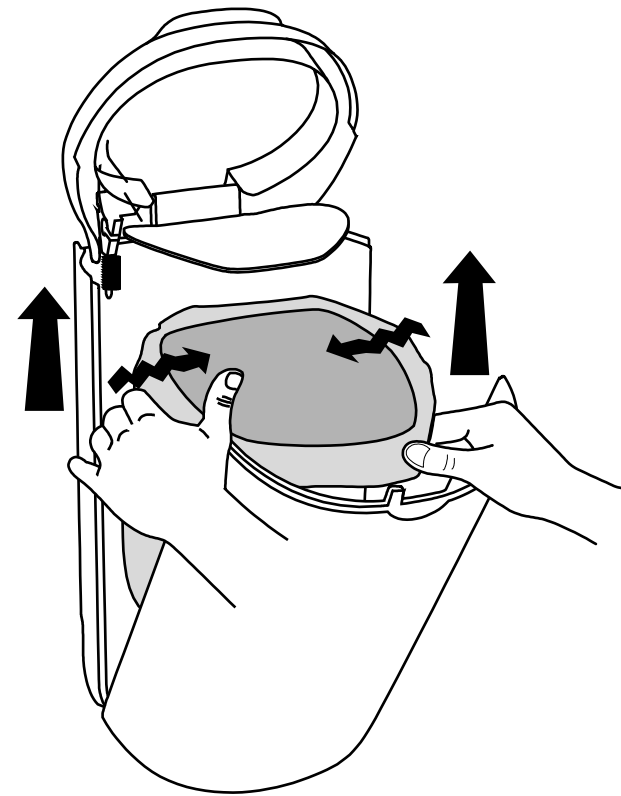

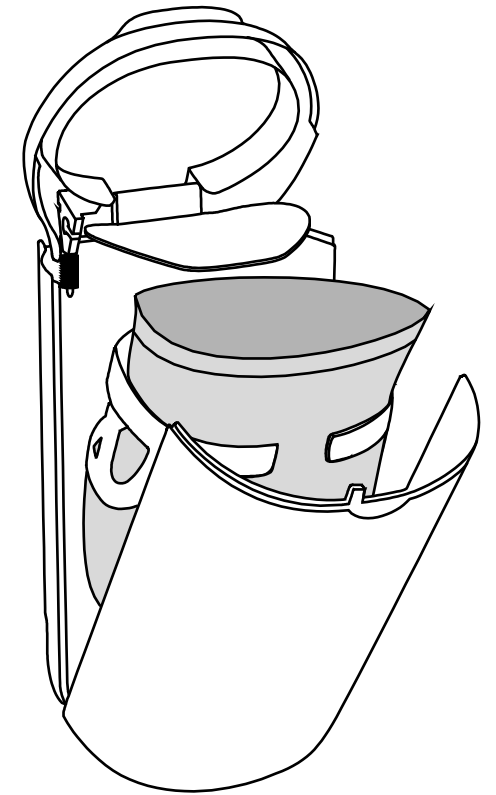

2.

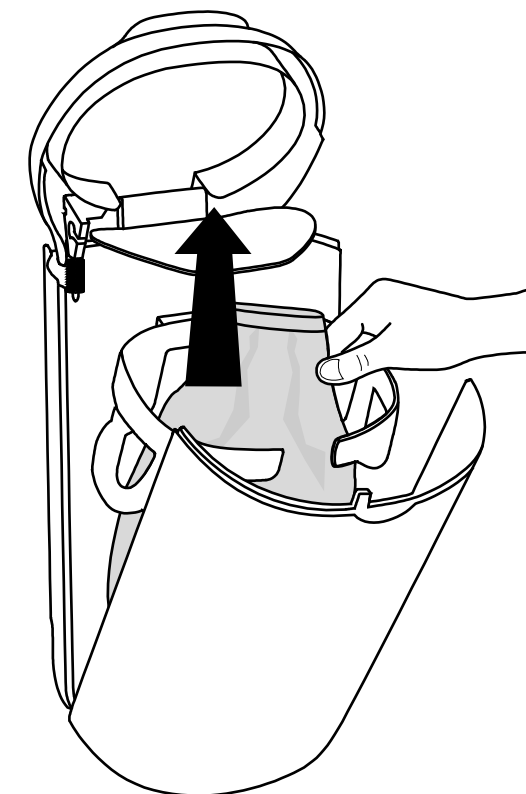

3.

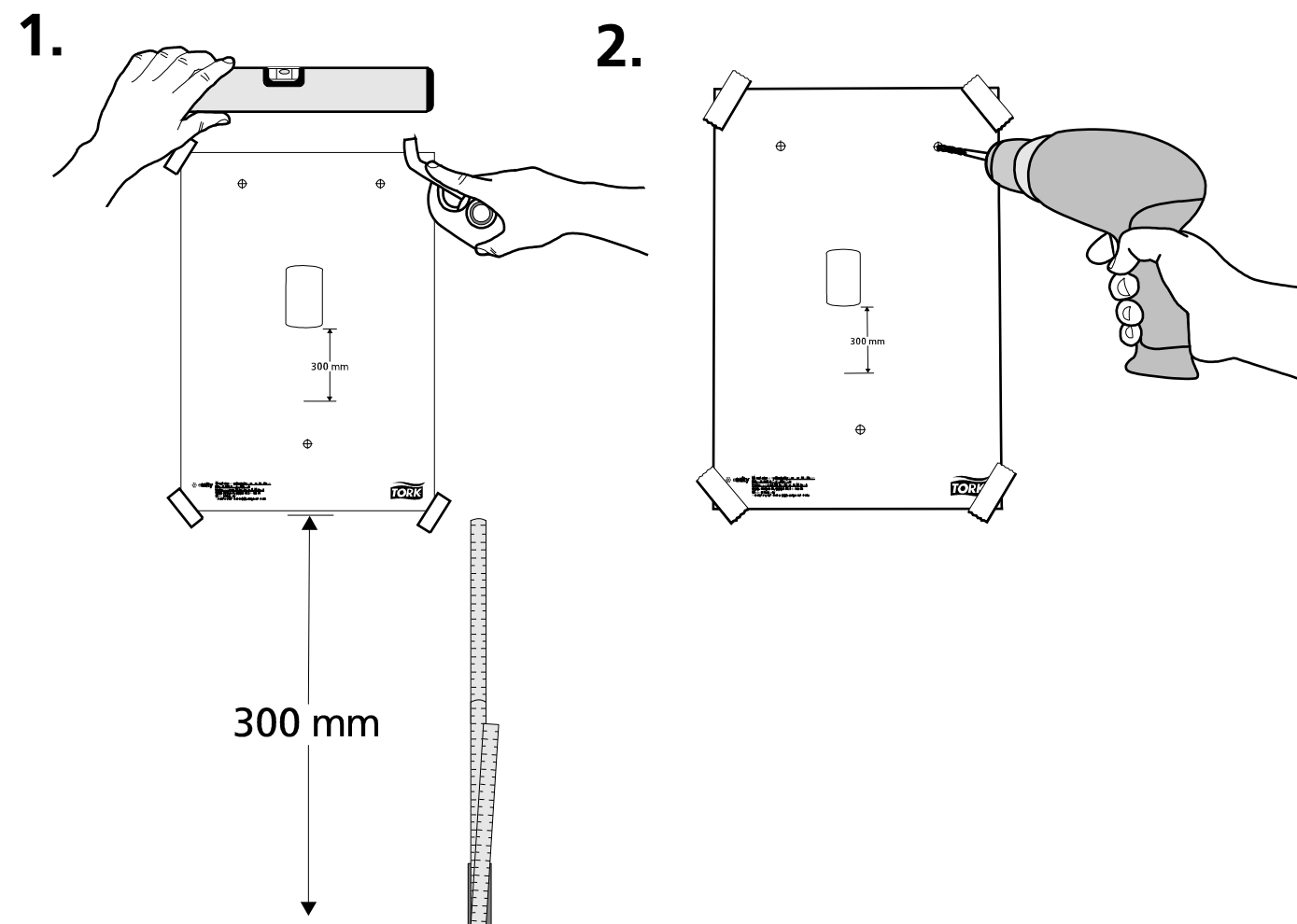



 x 3  x 3

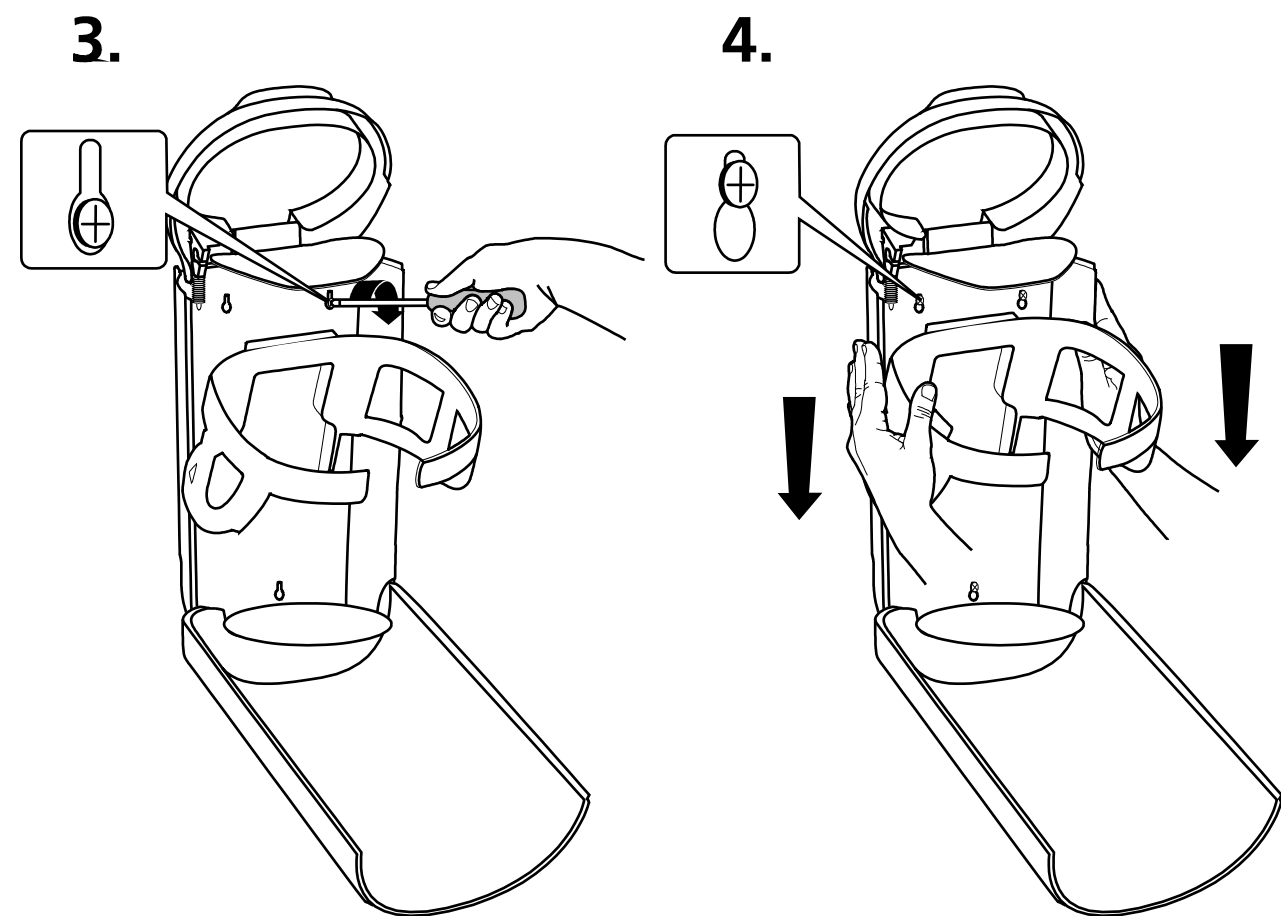

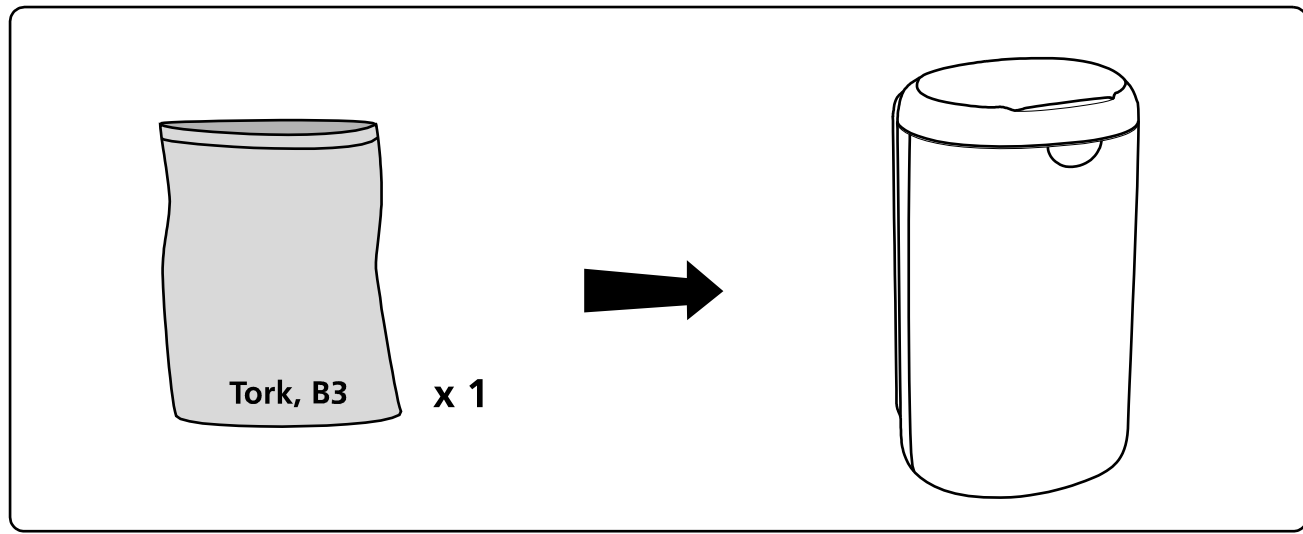

1.

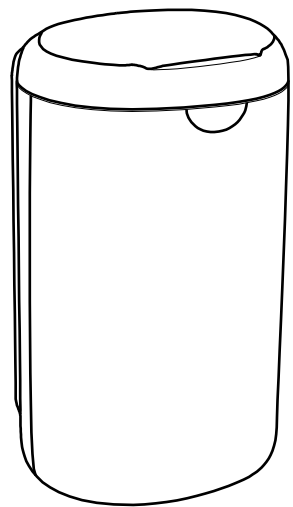

2.

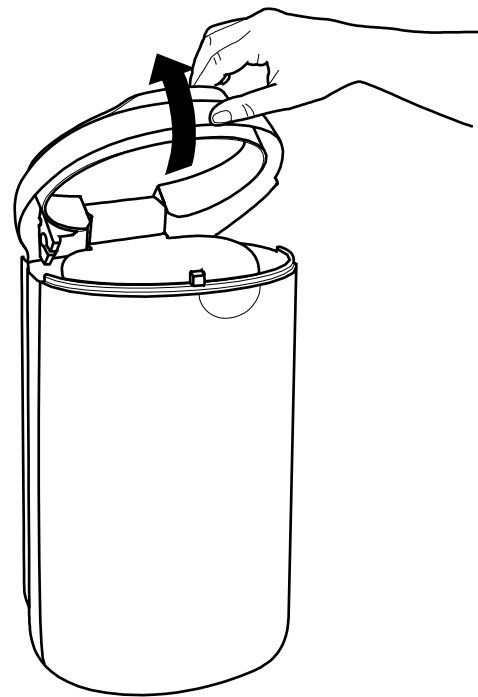

3.

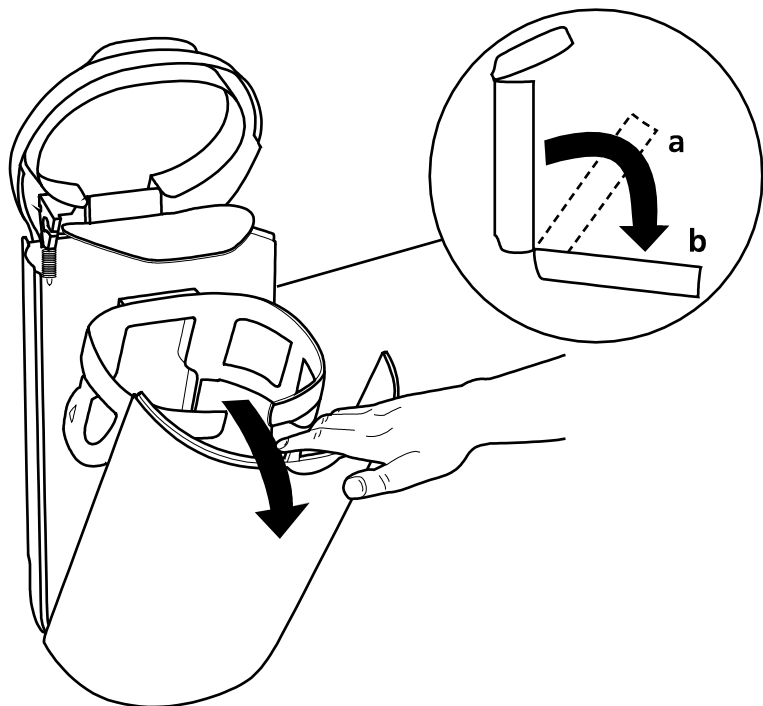

4.

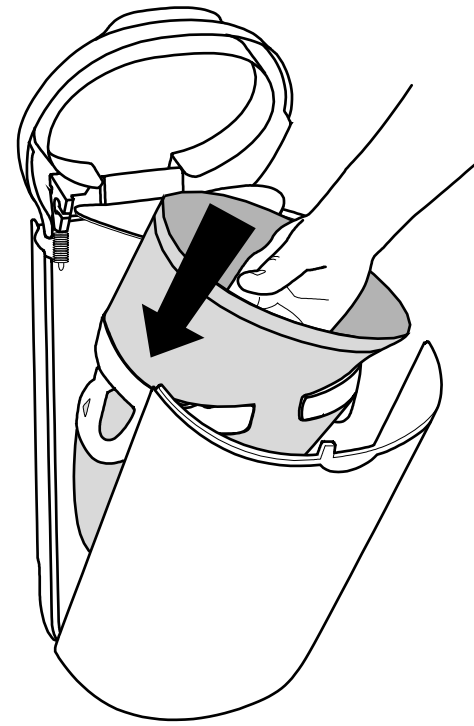

5.

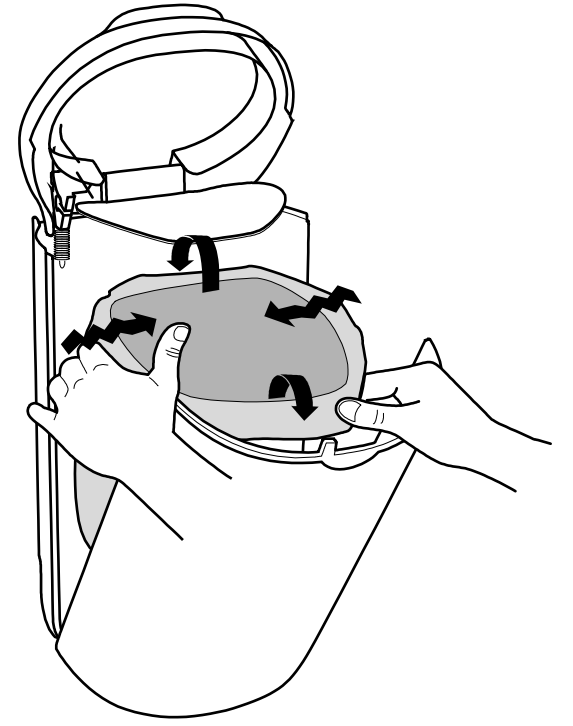

6.

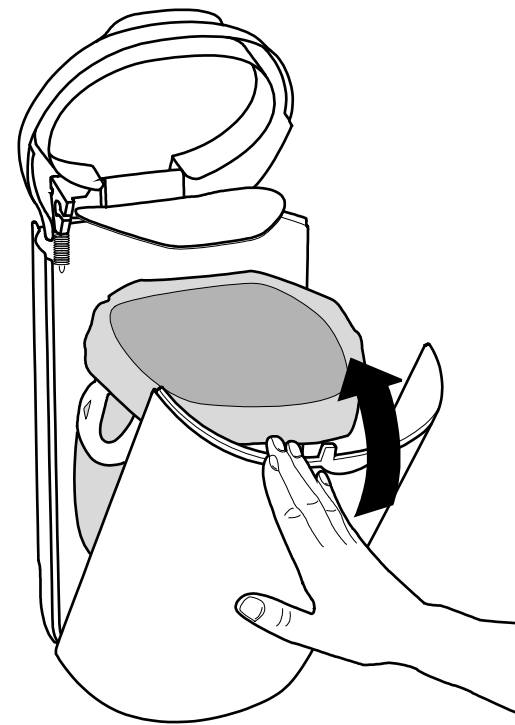

7.

